

Geberit International Sales AG
CH-8640 Rapperswil
Switzerland

sales@geberit.com

→ www.international.geberit.com

 **GEBERIT**

Sound insula- tion

Simple and safe with system

**KNOW
HOW
INSTALLED**



Disclaimer

All information contained in this document, which is based on or which refers to standards, ordinances or regulations etc., has been thoroughly researched and compiled with the greatest possible care. However, we cannot guarantee that such information is correct, complete or up to date.

Further product information

Further product information is available at www.international.geberit.com.

Copyright

All rights reserved. Texts, images, graphics etc. as well as their arrangement are subject to copyright protection.

© Copyright by Geberit International Sales AG, Rapperswil, 2012

Noise: the underestimated danger to the environment.

All day long, we are surrounded by sounds. Whether we perceive them as noise, does not depend on the objectively measurable volume alone. Therefore even the noise of waste water draining from a neighbour's apartment at night when it is quiet can result in a very real negative effect on the quality of life. With good planning and acoustically optimised installation systems, specialist planners and plumbers ensure that the waste water installation does its job in a whisper-quiet way and without causing annoying noise.

1	The Geberit Group	5
2	Acoustics and statics	7
3	Noises in the context of sanitary installations	13
4	Measures for optimum sound protection	19
5	Geberit waste & drainage system	25

1 The Geberit Group

The Geberit Group is the European market leader in sanitary technology with global presence. From the time of its establishment in 1874, the company has always been a pioneer in the sector, consistently setting new trends with its comprehensive system solutions.

Geberit operates sales offices in 41 countries. Sales activities are concentrated on the major European markets with great growth opportunities, mainly in Central and Eastern Europe, the United Kingdom, North America, China and South East Asia.

The company employs 6'200 people in 41 countries. Our sales force, technical advisors and service personnel will be pleased to offer support and answer any of your questions.

Please contact your local market organisation for further information or get in touch with Geberit at www.international.geberit.com.

2 Acoustics and statics

2.1	Research at Geberit	8
2.2	What is acoustic noise?	9
2.3	Sensitivity to noise and noise perception are subjective	10
2.4	Solid-borne sound and airborne sound	11

2.1 Research at Geberit

As a forward-looking and innovative company specialising in sanitary technology, Geberit is not just interested in meeting challenges, but actively seeks them out. Acoustics and statics are just two of the nine areas of technology in which Geberit is currently investing. Together, they are helping to set new trends in the latest developments and the optimisation of products. The company's Building Technology and Acoustics Laboratory, which is the only one of its kind in Europe, is used to test the acoustic and static characteristics of individual components as well as entire installation systems.

The highly qualified engineers and specialists bring their technical knowledge and experience to bear in the field of applied research and use them to optimise Geberit products.

Amongst other things, the purpose-built laboratory can be used to simulate sound transmission in a multi-storey residential building. As a result, it is possible to test and improve the noise behaviour not only of individual components, but also of entire installation systems. A wide range of tools and equipment have been developed in-house for the structural statics tests that are used to test the load bearing capacity and deformation of Geberit products.



2.2 What is acoustic noise?

From a physical standpoint, the acoustic noise which reaches our ears is a vibration of air molecules, which produces small pressure fluctuations in the ear. The intensity of acoustic noise is thus indicated by fluctuations in air pressure. Because these fluctuations cover a range of between one and one billion, we express the acoustic noise level on a logarithmic scale "the decibel unit (dB)".

Above 40 dB(A) a decrease or increase in the acoustic noise level of 10 dB(A) is perceived as the loudness doubling or halving. Only differences in the acoustic noise level of at least 3 dB(A) are discernible. There is no point talking about differences of 1 dB(A).

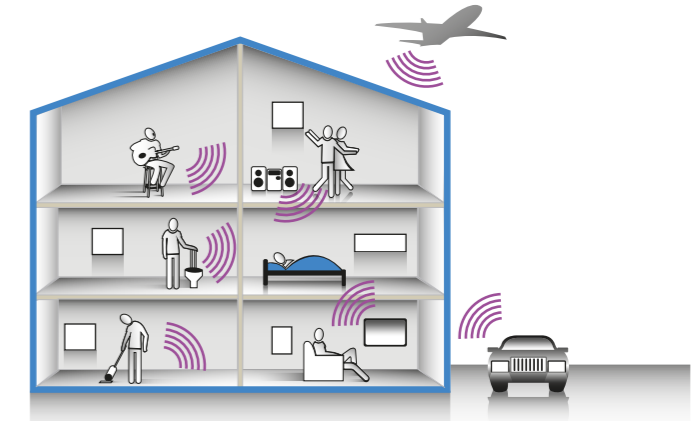

Noise levels in every day life

The quiescent level in a building is approx. 20 dB(A). This value depends on the general quality of the building construction. In the case of poor external insulation (windows), the quiescent level may be as high as 25/30 dB(A).

Sound pressure level of different sound sources and acoustic effects

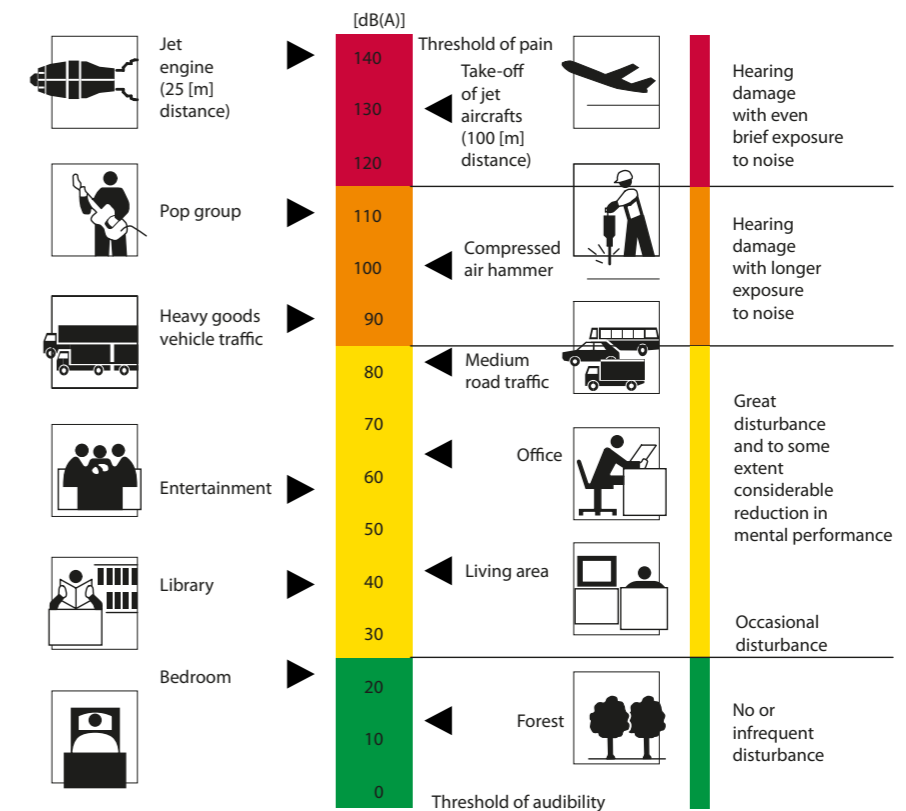

2.3 Sensitivity to noise and noise perception are subjective

Different people respond to sound in different ways. Often, it is not the volume of noise that is the key factor in determining whether someone reacts positively or negatively, but the type of noise involved.

The best example of this is that a dripping water faucet (extremely low sound level) can be more annoying than loud music (high sound level) at a rock concert.

The difference between sound (pleasant) and noise (unpleasant) is that noise is always what someone else is making and not what I myself am doing (sound).

DIN standards in the context of sound insulation

Maximum permissible sound level values have been established (e.g. DIN in Germany) in order to protect other persons in adjacent third-party areas.

DIN standards enjoy international recognition. However, sound insulation guidelines may vary depending on country-specific factors.

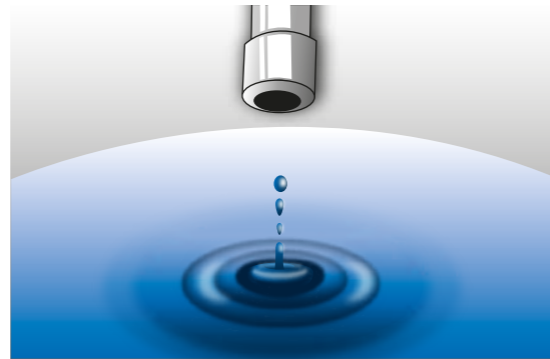

A dripping water tap is measured at 20 dB(A) but can drive people crazy.



A concert can have more than 100 dB(A) and is mostly very pleasant.

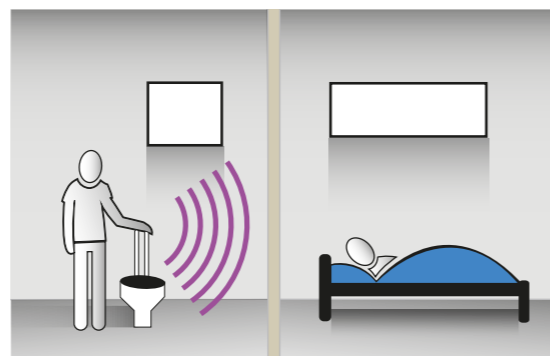

The sleeping person is disturbed by the noise. For the man this is no problem because the occurring sound is normal.

2.4 Solid-borne sound and airborne sound

Solid-borne sound is acoustic noise which emanates from something solid. This includes various phenomena such as tremors and earthquakes which transmit vibrations to buildings, vehicles, machines etc. Solid-borne sound can mainly be discerned by humans at low frequencies. It is only airborne sounds emanating from the vibrating solid object which are audible.

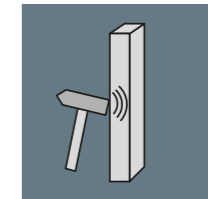

Airborne sound is defined as sound waves which spread through the air. Airborne sounds are generated by humans, animals, installations or machines and spread through the air. Solid components contain airborne sound.

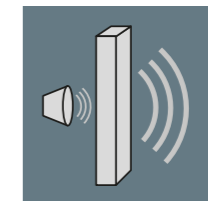

Measures for preventing or reducing airborne and solid-borne sound

The term "sound insulation" primarily refers to measures designed to prevent sound from being generated in the first place but at a secondary level it also refers to measures designed to prevent sound transmission.

Airborne sound has to be encapsulated

- by heavy duct walls
- by sound insulation pipes

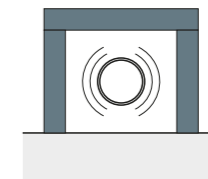

Solid-borne sound has to be separated by means of soft, insulated fastenings and insulation of wall and ceiling penetrations. If solid-borne sound insulation is not implemented consistently, sound bridges can result that undermine the success of the sound insulation measures.

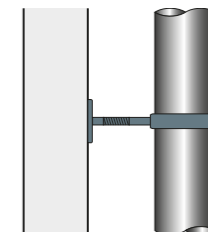

3 Noises in the context of sanitary installations

3.1	Transmission of noise and how to determine it	14
3.1.1	Bathroom example	14
3.1.2	Maximum permissible sound levels	14
3.1.3	EN14366	15
3.2	Differentiation of noises in pipes	16
3.2.1	Distinction between falling, impact and flow noises	16
3.2.2	Falling, impact or flow noise?	17

3.1 Transmission of noise and how to determine it

3.1.1 Bathroom example

In the specific example of a bathroom, sound is generated, propagated and transmitted to other rooms as well.

1. The use of the flush in the source of noise and radiation of airborne sound which transmits into the construction and changes into solid-borne sound.
2. The solid-borne sound transmits within the construction and affects the construction in the way that airborne sound radiates in the reception room.

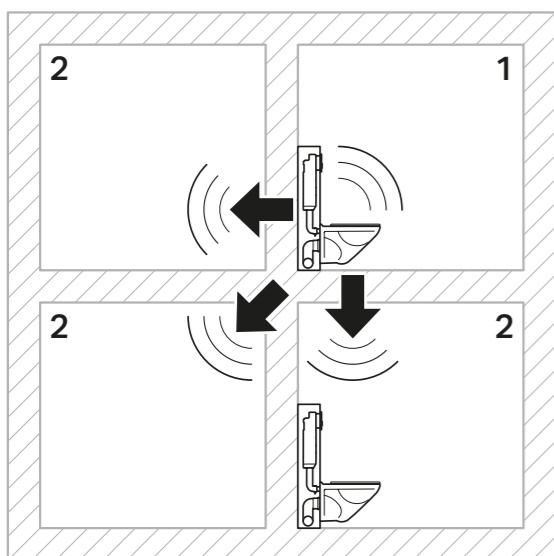

3.1.2 Maximum permissible sound levels

DIN is used to determine the maximum permissible sound pressure levels in adjacent third-party areas (marked here in yellow).

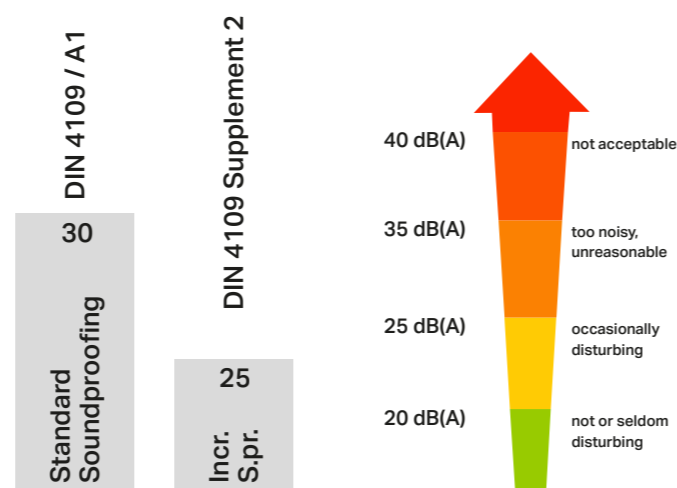

3.1.3 EN 14366

A widely used method for measuring the sound characteristics of outlet pipes is a test in accordance with the standard EN 14366.

The results from this test do not give an accurate picture of whether a complete pipe installation, including valves, toilets, etc. will comply with the specific noise requirements of a building.

A test in accordance with EN 14366 solely measures the noise from the stack and does not take into account the noise that might come from the toilet flushing or the water flowing from the service pipe into the stack. Furthermore, the measurement is taken while water flow is constant. In practice, the water flow through the pipe when a toilet flushes, for example, is more turbulent. In accordance with EN 14366, valve noise is not measured.

Standards cannot be used for comparisons

The test standard EN 14366 is not a tenable method for calculating the acoustic conditions of pipe installations in specific cases. Instead, the primary use of the test standard is to compare different pipe products. However, the test does have shortcomings when it comes to comparing products. The crucial reason is that EN 14366 does not stipulate requirements for the installation of the outlet pipe, other than that it is secured by two pipe brackets on the ground floor and first floor. How the fitting is carried out, and not least which pipe brackets are used and how they are attached, are not part of the test standard, but must be carried out in accordance with the manufacturer's instructions. This allows the use of the most optimal installation, including the type of pipe bracket and how tightly the pipe brackets are fitted to the tube. For example, waste water noise can be significantly reduced by using specially designed pipe brackets. It is also generally known that it makes an important difference how tightly the pipe brackets are fitted. Therefore, the variations in differently fitted installations may be so great that EN 14366 is not an accurate benchmark for comparing discharge pipes.

3.2 Differentiation of noises in pipes

3.2.1 Distinction between falling, impact and flow noises

Noises and sound are generated at various points in sanitary installations. In order to carry out an assessment and design sound insulation measures accordingly, a distinction has to be made between the different types of noise involved.

In the case of discharge pipes, a distinction is made between falling, impact and flow noises. In turn, these result in airborne and solid-borne sound.

3.2.2 Falling, impact or flow noise?

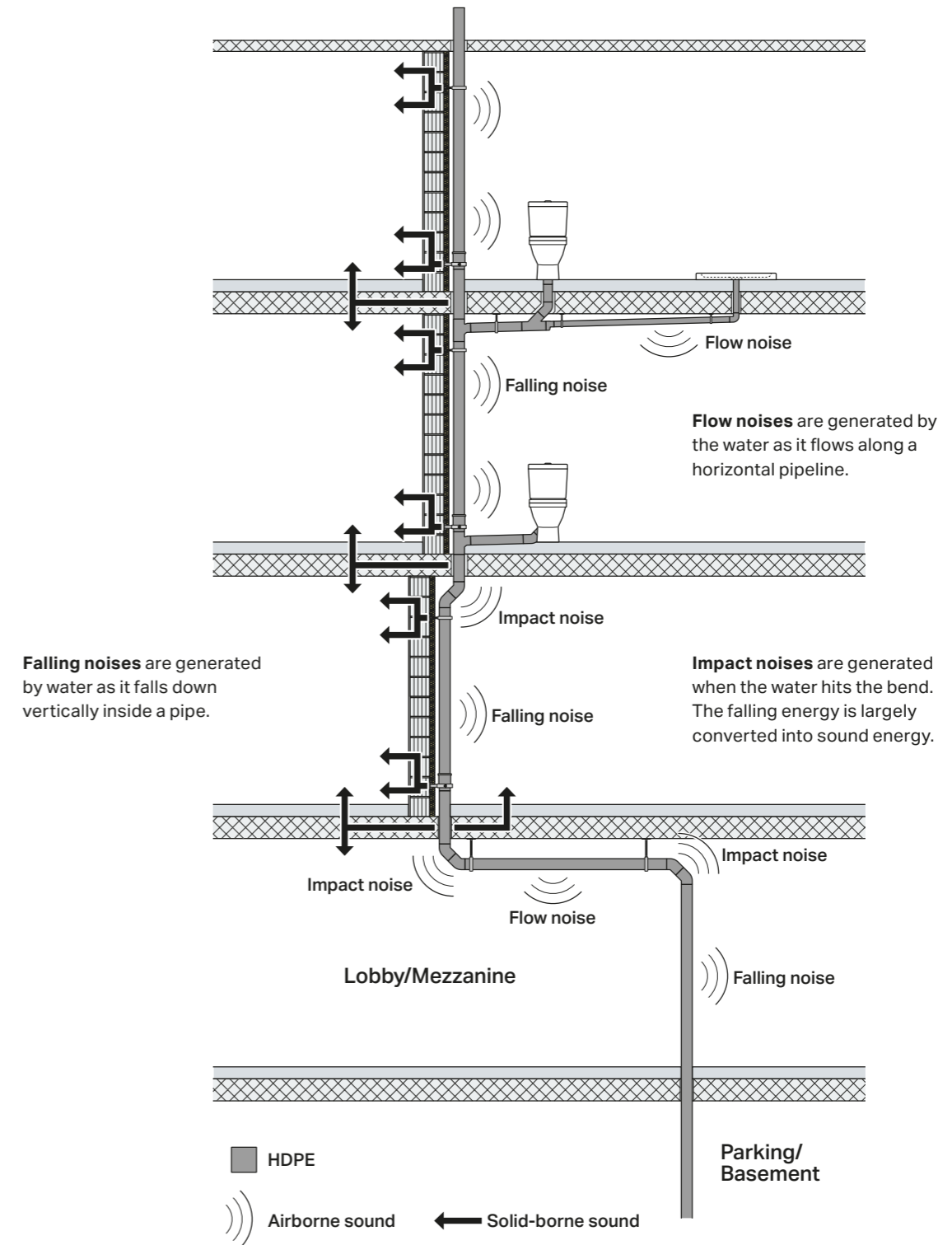

4 Measures for optimum sound protection

4.1	Basic measures at planning stage	20
4.1.1	Basic consideration	20
4.1.2	Optimum ground plan layout	20
4.1.3	Optimum sanitary installation	21
4.2	Sound measures – basics	22

4.1 Basic measures at planning stage

4.1.1 Basic consideration

In order for low sound levels to be achieved, a number of basic measures need to be implemented as early as the planning stage.

The key factors here are ensuring an optimum ground plan layout and an optimum pipe layout. The desired sound insulation values cannot normally be achieved by attempting to make improvements at a later date.

4.1.2 Optimum ground plan layout

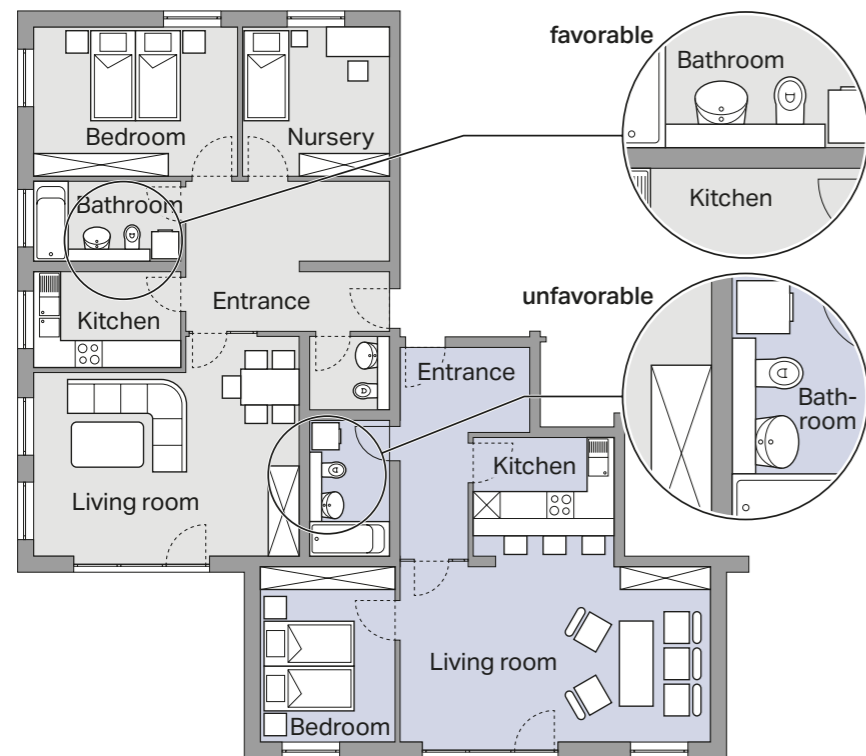

When designing the ground plan layout, it is essential to keep groups of rooms with higher sound insulation requirements separate from rooms that are likely to generate a lot of noise. Sanitary units should be grouped together or arranged one on top of the other.

Partitions, doors and installations should be installed by combining them and coordinating them so that the desired level of sound insulation is achieved without compromise.

4.1.3 Optimum sanitary installation

Setting up an optimum pipe layout means making sure that the discharge stacks are as straight as possible and that offsets are avoided whenever possible. The example below demonstrates the increase in noise level. This increase is always specified in relation to the value for a straight discharge stack.

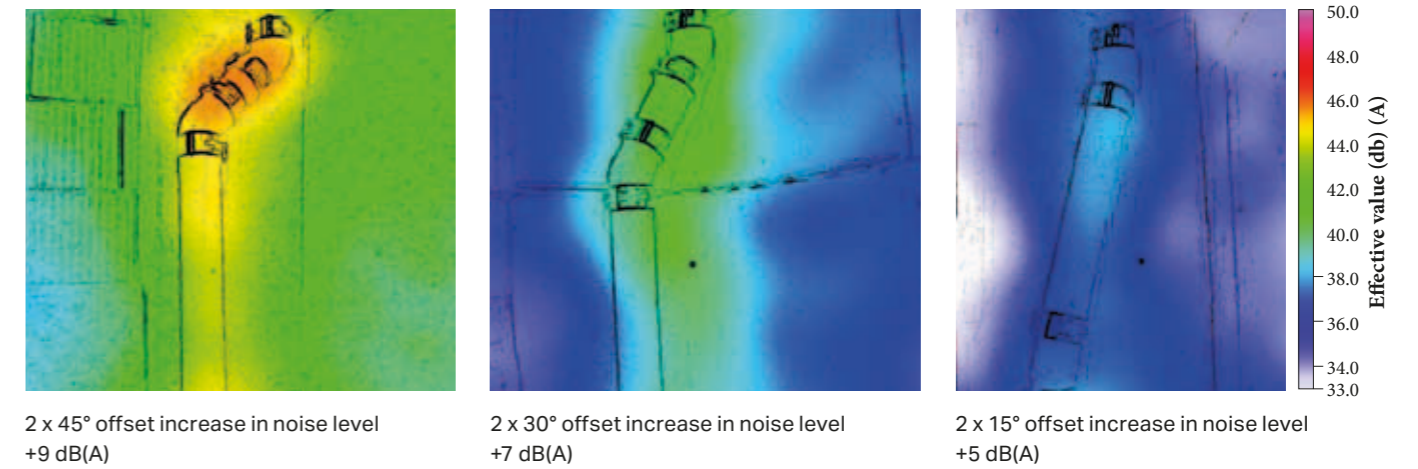

The above illustration was produced at the Geberit sound laboratory using a specially designed camera. The camera records the sound inside the piping system and converts it into a colour image.

Pipes should be laid inside ducts. The insulation inside the ducts has an important role to play.

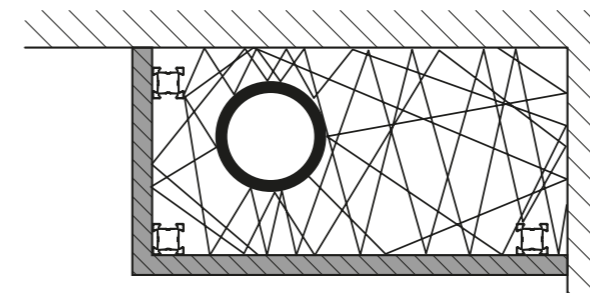

In a non-insulated duct, the sound waves bounce off walls as reflections until they are absorbed.

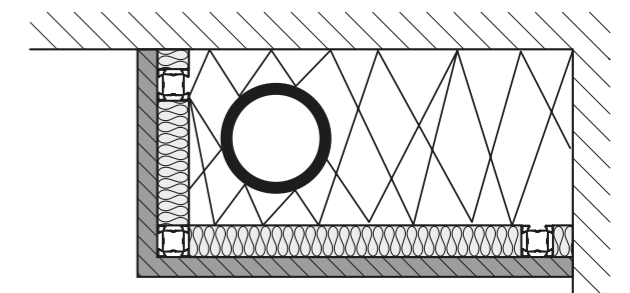

In an insulated duct, the sound waves are absorbed. Duct lining on at least 2 sides with 30 mm of mineral wool prevents an increase in the level of 10 dB(A) in the duct.

4.2 Sound measures – basics

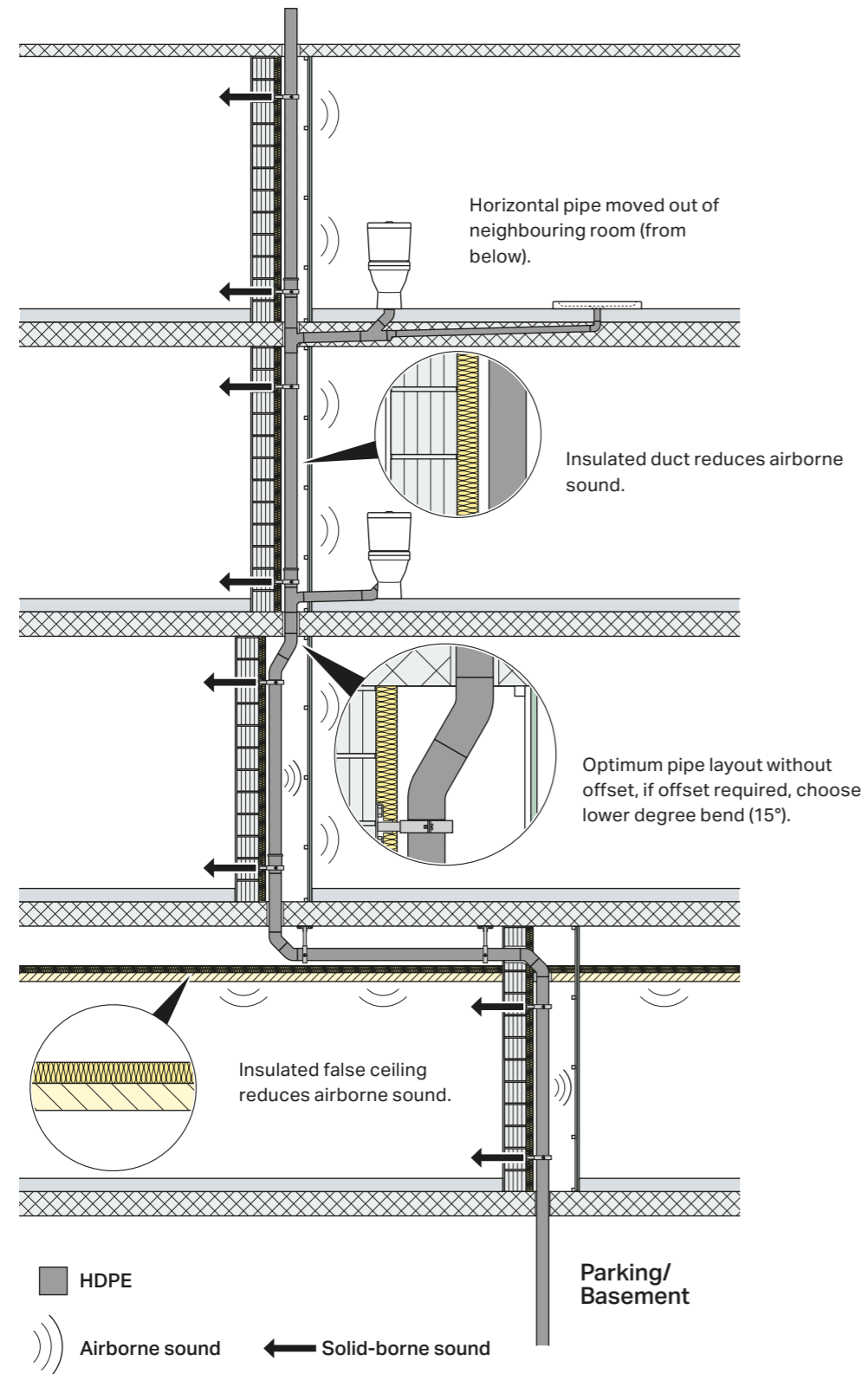

5 Geberit waste & drainage system

5.1	Geberit HDPE	26
5.2	Geberit Silent-db20 sound insulation solution	27
5.3	Characteristics of Geberit HDPE and Geberit Silent-db20	28-29
5.4	Geberit Silent-db20 compatible to Geberit HDPE	30
5.5	Sound values for Geberit Silent-db20	31
5.6	Extended sound measures	32
5.7	Geberit Isol	33
5.7.1	Characteristics	33
5.7.2	Geberit Isol in practical	34
5.7.3	Sound measures with Geberit Isol	35

5.1 Geberit HDPE

Unless a higher level of sound insulation is required and assuming that all the necessary structural sound insulation measures are in place, Geberit HDPE is the perfect solution.

The pipes and fittings are made from high-quality and environmentally friendly HDPE. The company's many years of experience in the field of plastics manufacture ensures excellent longterm quality.

The Geberit HDPE range is suitable for use in all building drainage applications as well as in industrial, commercial or laboratory waste water installations.

The Geberit HDPE drainage system meets every single requirement from the waste fitting right through to the collector or underground pipes.

Geberit HDPE pipes and fittings are completely leakproof and can also be laid in concrete.

The product features of Geberit HDPE provide a good level of solid-borne sound insulation. Nevertheless, Geberit HDPE is not as effective at reducing airborne sound as Geberit Silent-db20. Therefore, if you need even better protection from airborne sound, we recommend using Geberit Silent-db20.



5.2 Geberit Silent-db20 sound insulation solution

Geberit Silent-db20 has very good soundproofing properties because of its significantly increased mass.

The product is made of mineralreinforced HDPE. The material is UV-resistant due to 2% soot, recyclable, can be welded with Geberit HDPE and its chemical characteristics are like HDPE.

The ribs have a vibration dampening effect and reduce the vibration of the pipe and therefore the emission of airborne sound.

Geberit Silent-db20 is a drainage system that has been optimised with regard to airborne sound insulation. With diameters ranging from 56 to 160 mm and a choice of almost 100 different fittings, it represents a complete range of sound insulation products.



Geberit Silent-db20 is certified to DIN 4109 and DIN 4102-22. Numerous other certificates also apply, including ISO and SQS.

5.3 Characteristics of Geberit HDPE and Geberit Silent-db20



Geberit Silent-db20 bears the same characteristics like Geberit HDPE. It only differs with regard to its improved sound properties. For optimised airborne sound insulation Geberit Silent-db20 is always the best solution.



Resistance to hot and cold

Geberit HDPE can be safely used as waste pipe with no mechanical load, up to 80°C. Temperatures of up to 100°C for short periods (e.g. surges of steam) are permissible. When Geberit HDPE parts are filled with water and then freeze, they stretch elastically as the ice expands. Once the ice melts, they resume their original shape, remaining completely intact and undamaged.

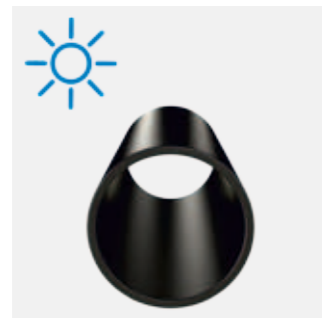

Solar radiation

Geberit HDPE pipes are protected against ageing and embrittlement caused by UV rays by the addition of approximately 2% soot. That is why pipes can be stocked outside for months.



Cast in concrete and prefabrication

The extraordinarily tough and robust Geberit HDPE pipes are safe to embed in concrete or install in the ground if the static and other generally acknowledged rules of technology are observed. Thanks to a wide range of fittings, proven tools and a low material weight, the Geberit HDPE waste and drainage system is perfectly suited for prefabrication in plumber's own workshop.



Completely leakproof

Welding joints ensure 100% tightness and provide a high security for decades.



Resistant to chemicals

HDPE ideal for use in industrial and laboratory installations. The material covers different application fields. There is no need to change the pipe material.



Non-toxic

With the connection method welding, there is no need to use solvents during the installation. The installers are protected from hazardous goods. HDPE is also well suited for use in the food industry as packaging material, containers, bottles etc.



Resistant to abrasion

Drainage systems are increasingly exposed to scratchy waste. HDPE is highly resistant to abrasion. Its extra thick walls offer additional protection. The function of the drainage pipe is ensured for decades.



Resistant to impact and highly flexible

Geberit HDPE is unbreakable at room temperature. Its resistance to impact is very high even at extremely low temperatures down to approx. -40°C. The impact resistance ensures, especially during the building time, that the risk of breaking pipes through mechanical influences is minimized. Due to its flexibility, Geberit HDPE fulfils all requirements of nowadays challenging constructions.



HDPE is a soft material with a low E-modulus. Therefore, Geberit HDPE limits solid-borne transmission.

When it comes to airborne noise, due to the vibration, Geberit HDPE creates some airborne sound. Geberit Silent-db20 has very good soundproofing properties because of its significantly increased mass.

5.4 Geberit Silent-db20 compatible to Geberit HDPE

The Geberit Silent-db20 drainage system is capable of withstanding considerable loads and can be combined with the conventional Geberit HDPE range.

The pipe bracket with rubber insert is specifically tailored to the Geberit Silent-db20 system. The low level of strain ensures tension-free installation on site.

The great advantage of Geberit Silent-db20 is its compatibility to Geberit HDPE. This is seen most readily when the two systems are processed together: Geberit Silent-db20 can be welded together with Geberit HDPE. The processing and the laying technique of Geberit Silent-db20 are identical to those of Geberit HDPE.

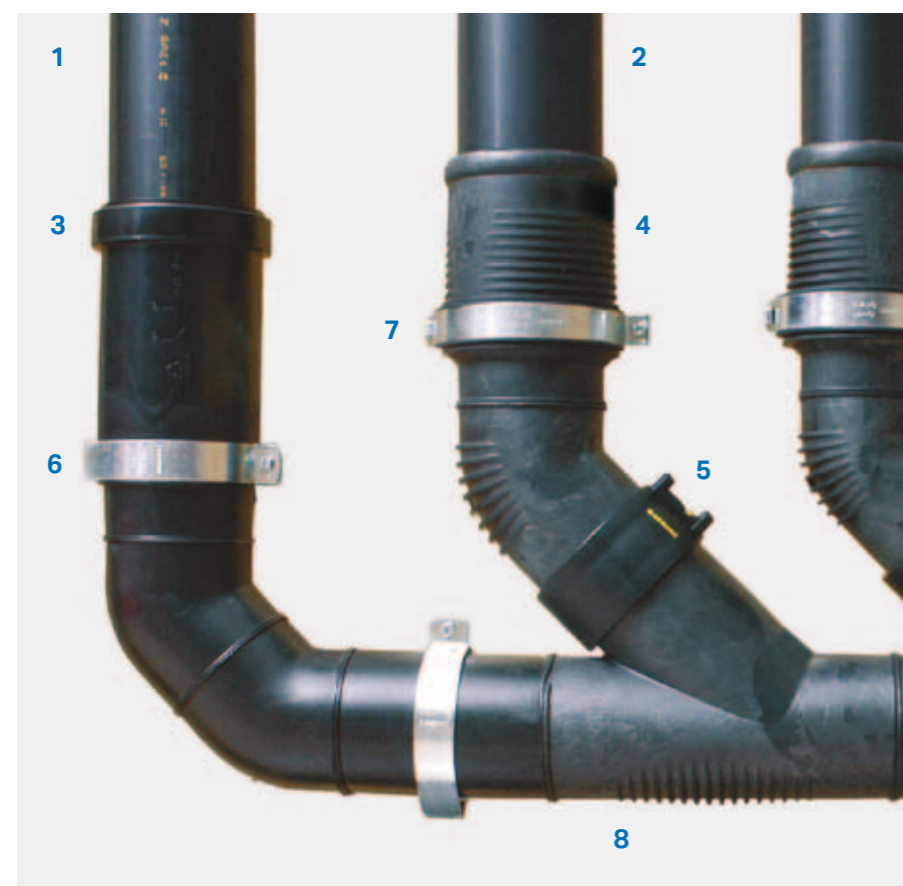

1. Geberit HDPE
2. Geberit Silent-db20
3. Expansion socket (HDPE)
4. Expansion socket (Geberit Silent-db20)
5. Electro sleeve coupling
6. Geberit HDPE pipe bracket (anchor point)
7. Geberit Silent-db20 pipe bracket (anchor point)
8. Butt welding (Geberit HDPE and Geberit Silent-db20 connected by means of butt welding)

5.5 Sound values for Geberit Silent-db20

The examples below illustrate the sound behaviour that the Geberit Silent-db20 exhibits in conjunction with various structural measures.

Dry wall duct (with insulation)

Pipe material:

Geberit Silent-db20 pipes and fittings Ø 110 mm, with electroweld sleeve couplings.

Mounting:

Geberit Silent-db20 pipe brackets with insulation insert.

WC mounting:

All connections between WC and wall are complete acoustical insulated.

Floor breakthroughs:

Insulated against solid-borne sound with acoustical insulation tape.

Partition wall-mounted:

Single-brick masonry 12.5 cm, plastered on one side, basis weight 180 kg/m².

Duct wall-mounted:

Metal post wall; i.e. supporting structure with double plasterboard finishing 13 mm, inside of duct with mineral wool. No contact with the connection pipe!

(Vol. flow in down pipe)	In room 1	In room 2
at WC flush A with 6 l	23 dB(A)	29 dB(A)

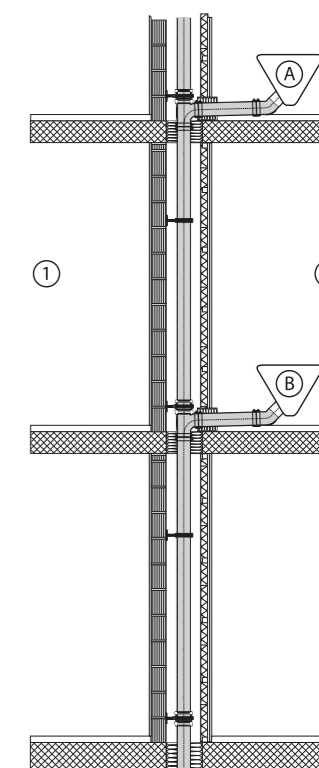

Installation in false ceiling

Pipe material:

Geberit Silent-db20 pipes and fittings Ø 110 mm, with electroweld sleeve couplings.

Mounting:

Geberit Silent-db20 pipe brackets with insulation insert.

Floor breakthroughs:

Insulated against solid-borne sound with acoustical insulation tape.

False ceiling:

In rooms smaller than 25 m² false ceiling has to be insulated.

*** Impact zone:**

The impact zone is the zone 2 m before and after the bend.

	Requirement dB(A)	additional insulation with Geberit Isol	required R _w , weighted sound reduction index for false ceiling
Room A	30	-	24
		in the impact zone	15
Room B	30	-	17
		in the impact zone	9

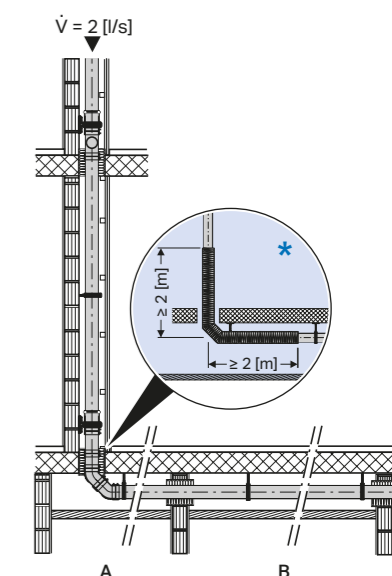

5.6 Extended sound measures

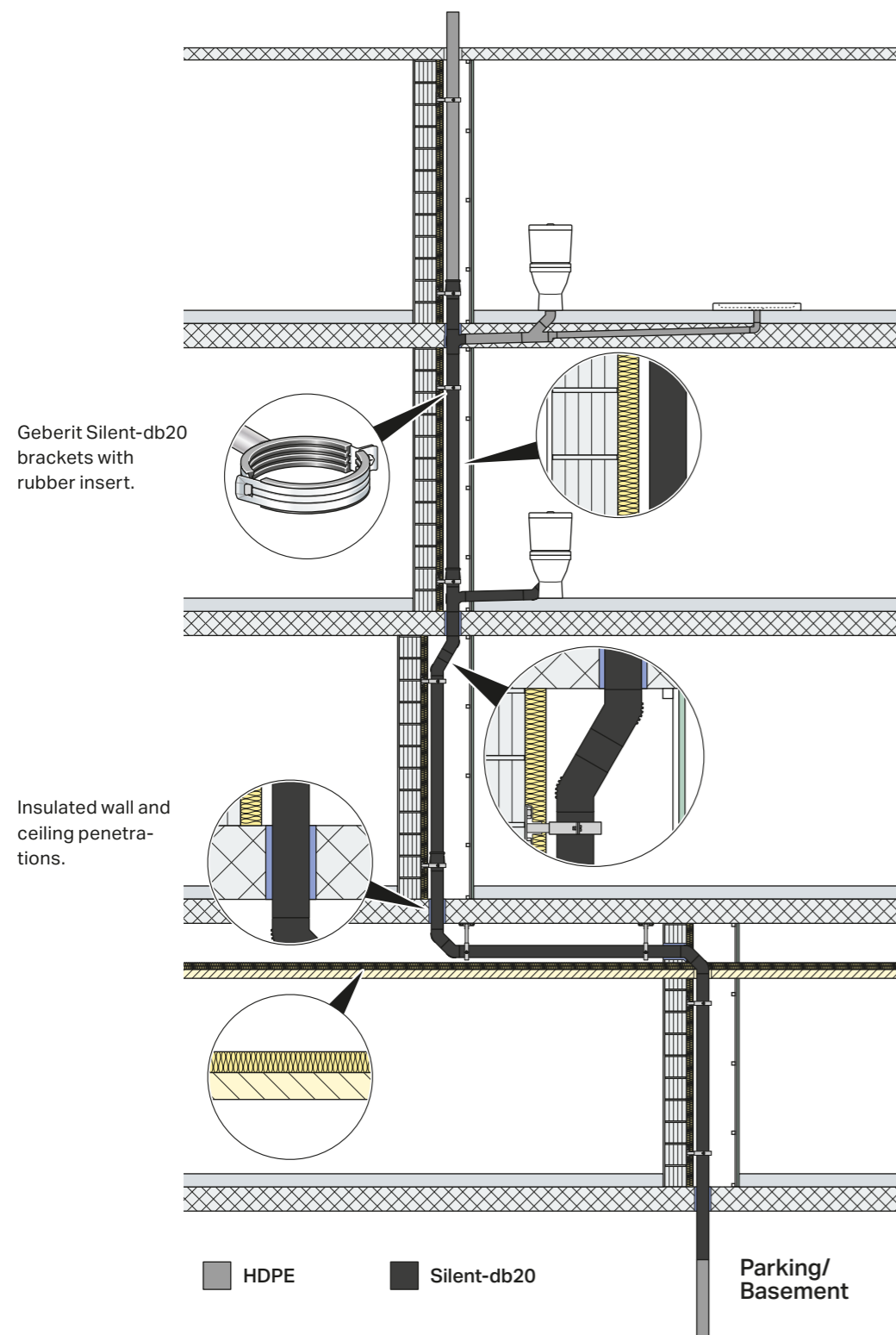

5.7 Geberit Isol

5.7.1 Characteristics

Geberit offers an additional product for airborne and solid-borne sound insulation: Geberit Isol. Whenever even higher sound insulation restrictions apply, Geberit Isol is used alongside Geberit HDPE and Geberit Silent-db20.

Geberit Isol consists of a covering foil that prevents the ingress of moisture, a heavy foil that provides insulation against airborne sound and a layer of acoustical convoluted foam that keeps the heavy foil at the correct distance from the pipeline (while at the same time reducing the transmission of solid-borne sound).

Thanks to the convoluted foam technology in particular, the key features of Geberit Isol are that it provides optimum sound insulation (by increasing the surface area by 30%).

Because Geberit Isol is lead-free and PVC-free it can be disposed easily and it poses no ecological hazards whatsoever.



5.7.2 Geberit Isol in practical

By using Geberit Isol, the sound level can be reduced by 10 to 12 dB(A) depending on the application.

Geberit Isol is suitable for universal use. For example, it can be used with Geberit Silent-db20, with Geberit HDPE or even with other pipe materials.

Geberit Isol can also be used as a «fix» for very specific localised problems on sections of a piping system (e.g. cladding when there is a change in direction, on offset pipelines).



When special Geberit HDPE fittings such as Sovent fittings, branchballs are used, they can be insulated against airborne noise with Geberit Isol. This ensures airborne sound insulation throughout the system.

A time-saving template for precision insulation of Geberit Sovent with Geberit Isol is available from Geberit in digital format on request.



The pictures hereafter show the sound difference between the application with and without Geberit Isol in colours.

Without Geberit Isol insulation:

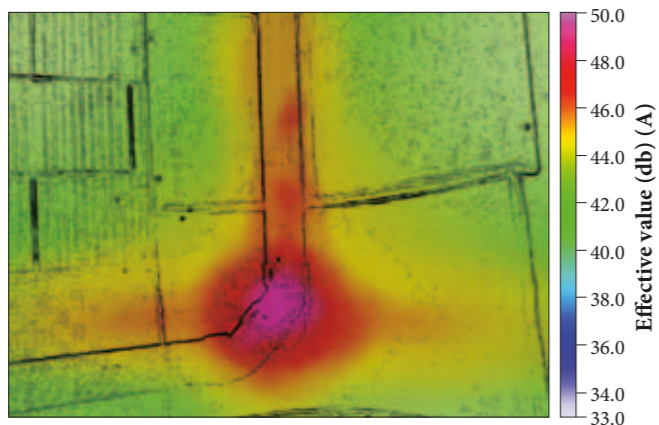

With Geberit Isol insulation:

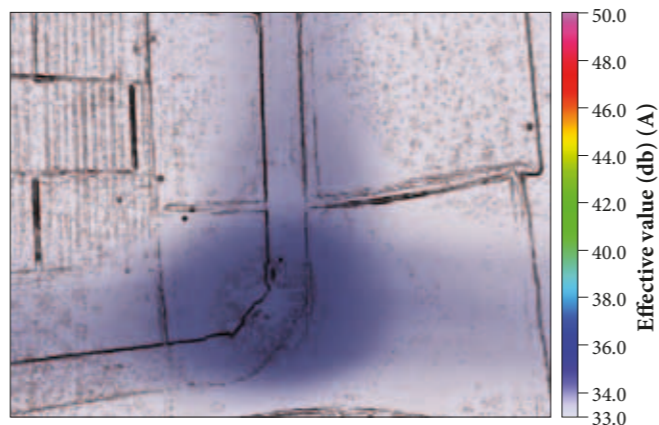

5.7.3 Sound measures with Geberit Isol

